



Arkay Windows

TECHNICAL DOCUMENTS

InfiniGLIDE3

InfiniGLIDE3 - Specifications



INFINI**GLIDE**

THE ULTRA SLIM NEW
SLIDING DOOR WITH A
20MM SIGHTLINE

Every horizon is worth seeing, and now you can enjoy amazing views from the comfort of your home. InfiniGlide 3 is the perfect, ultra slim frame to bring your outdoors inside.

Ultra slim 20mm interlock

Up to 2.2m x 3m per panel

Fully concealable frame

3 tracks and pocket door option

Fully openable and glass-to-glass corners

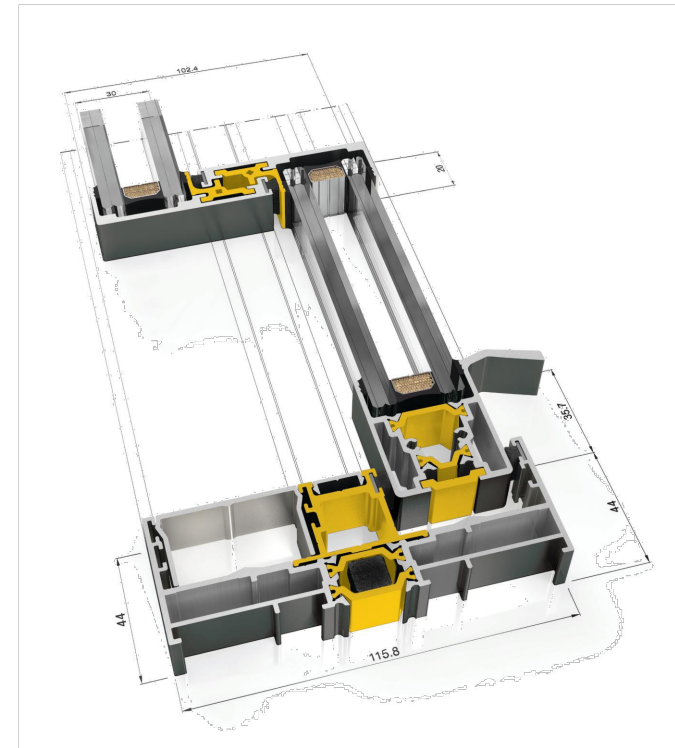

Size Limits

Maximum panel width	2200 mm
Maximum panel height	3000 mm
Maximum panel weight	320 kg

THRESHOLD HEIGHT	44 mm	
GLAZING THICKNESS	26-30 mm	
GLAZING METHOD	Structurally bonded	
MINIMUM SIGHTLINE	20 mm	
FRAME DEPTH	1 RAIL	116 mm
	2 RAIL	116 mm
	3 RAIL	182 mm

PERFORMANCE	
U-VALUE	From 1.3 W/m ² K
AIR PERMEABILITY	Class 4
WATER TIGHTNESS	Class 7A
WIND RESISTANCE	Class C5
MAXIMUM ACOUSTIC INSULATION	41 dB Rw

InfiniGLIDE3 - Contents

- 1.0 Typical Elevations
- 2.0 Standard Profiles
- 3.0 Typical Sections
 - 3.1 Duo Frame - Fixed Jamb
 - 3.2 Duo Frame - Locking Jamb
 - 3.3 Tri Frame - Fixed Jamb
 - 3.4 Tri Frame - Locking Jamb
 - 3.5 Duo Frame - Fixed Panel Threshold
 - 3.6 Duo Frame - Sliding Panel Threshold
 - 3.7 Tri Frame - Fixed Panel Threshold
 - 3.8 Tri Frame - Sliding Panel Threshold
 - 3.9 Duo Frame - Fixed Panel Head
 - 3.10 Duo Frame - Sliding Panel Head
 - 3.11 Tri Frame - Fixed Panel Head
 - 3.12 Tri Frame - Sliding Panel Head
 - 3.13 Interlocks - Standard
 - 3.13a Standard
 - 3.13b Standard - Reinforced Outside Only
 - 3.13c Standard - Reinforced Inside & Outside
 - 3.14 Meeting Section
 - 3.15 Duo Frame - Base Details
 - 3.15a 177mm / 190mm Drop Nose Cil
 - 3.15b 60mm cil nose
 - 3.15c Base gutter and drainage box
 - 3.16 Tri Frame - Base detail
 - 3.16a Base gutter and drainage box
 - 3.16b Cil drainage base
 - 3.17 Duo Head Trickle Vent
 - 3.18 Tri Head Trickle Vent
 - 3.19 Floating Corner Post
 - 3.20 Glass to glass Corner

InfiniGLIDE3 - Typical Elevations

DUAL TRACK
APPLICABLE FOR IN-LINE SLIDING

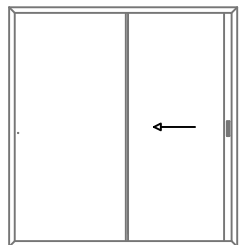

DUO RAIL
0X

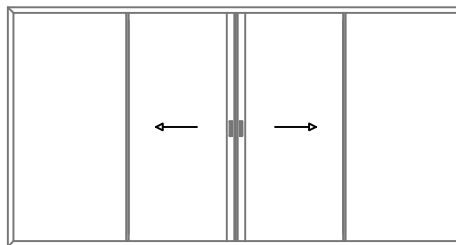

DUO RAIL
0XX0

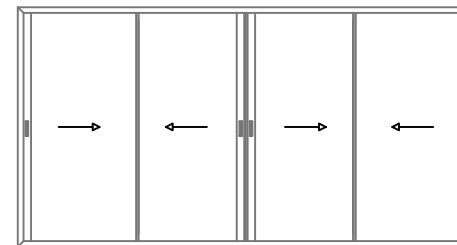

DUO RAIL
XXXX

TRIPLE TRACK
APPLICABLE FOR IN-LINE SLIDING

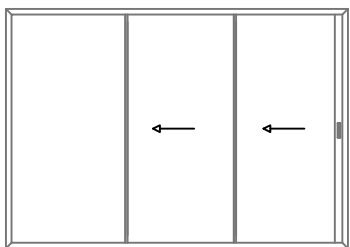

TRI RAIL
0XX

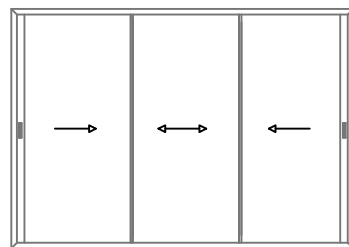

TRI RAIL
XXX

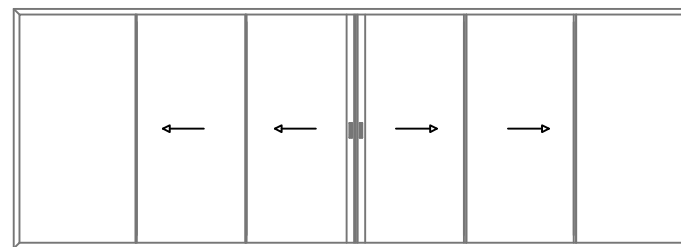

TRI RAIL
0XXXX0

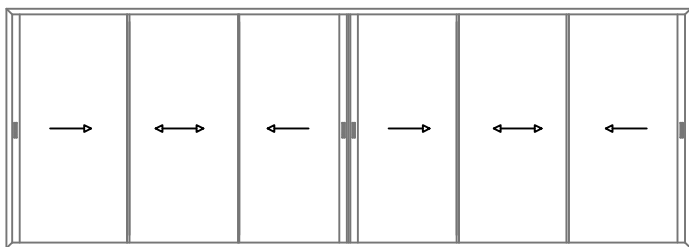

TRI RAIL
XXXXXX

InfiniGLIDE3 - Profiles

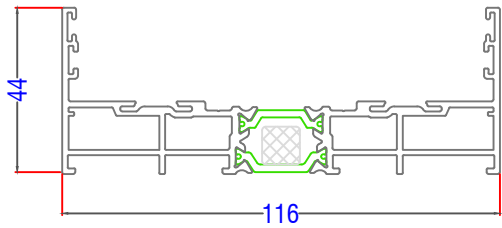

4389 - Duo Frame

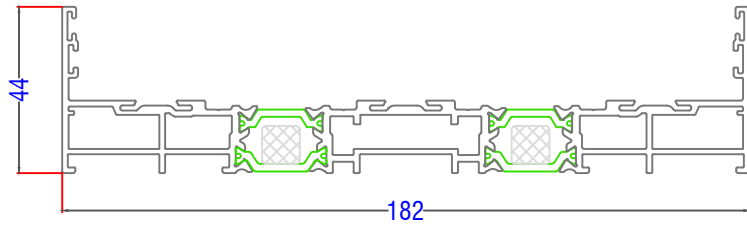

4391 - Tri Frame

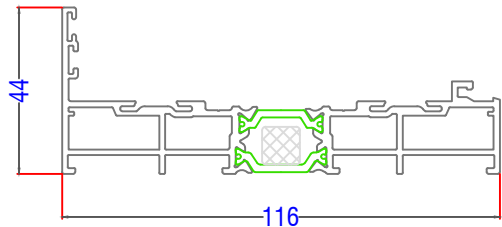

4385 - Duo Frame (Fixed Panel)

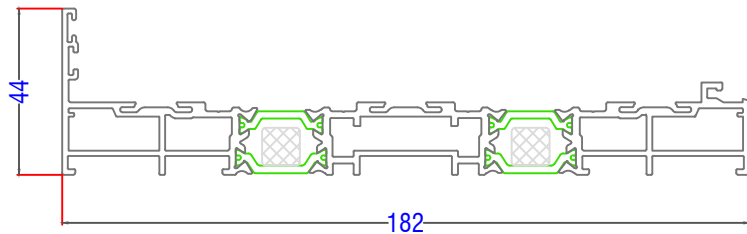

4387 - Tri Frame (Fixed Panel)

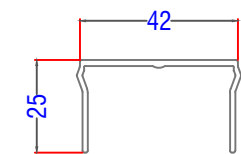

4336 - Frame Capping

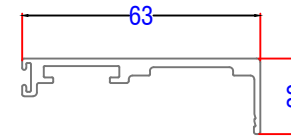

4326 - Interlock Standard

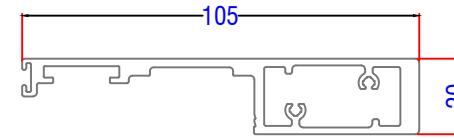

4327 - Interlock Reinforced

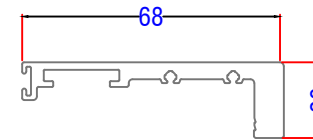

4326 - Interlock Fixed Panel

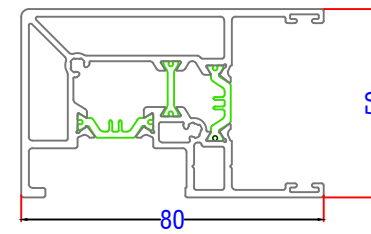

4387 - Tri Frame (Fixed Panel)

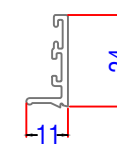

4365 - Frame Bead (Fixed Panel)

InfiniGLIDE3 - Profiles

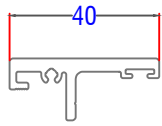

4350 - Meeting Profile

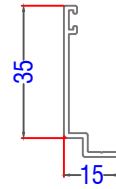

770229 - 35mm Add On Profile

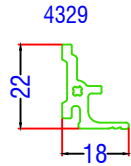

4329 - Interlock

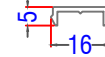

15919 - Centre Channel Screw Cover

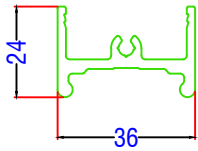

4324 - Bonding Sash Profile (PVC)

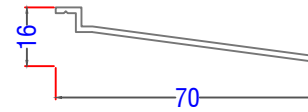

7056 - Cill Extension 60mm

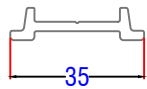

4325 - Bearing Profile

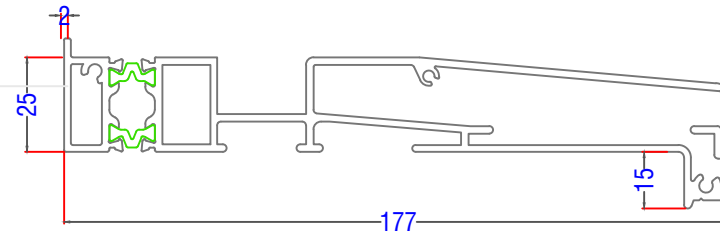

AW543 - 177mm Drop Nose Cill

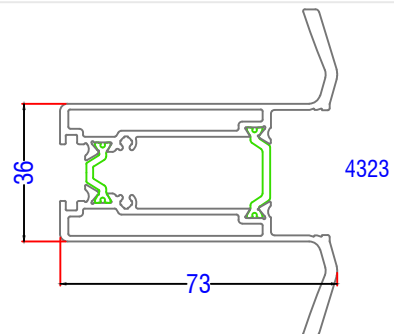

4323 - Sliding Sash Locking Profile

InfiniGLIDE3 - Profiles

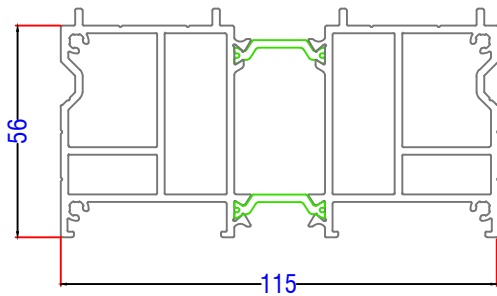

4302 - Duo Track Drainage Base

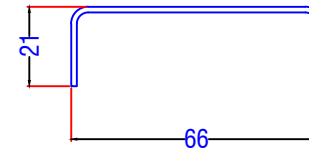

374800 - Gutter COver

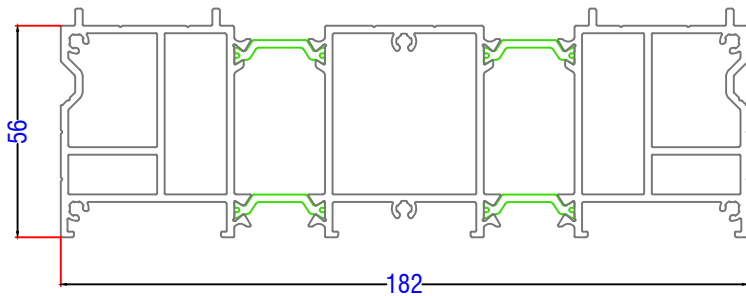

4304 - Tri Track Drainage Base

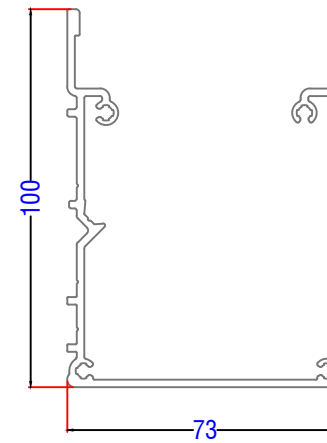

4891 - Gutter

InfiniGLIDE3 - Typical Sections

Duo Frame -Fixed Panel Jamb

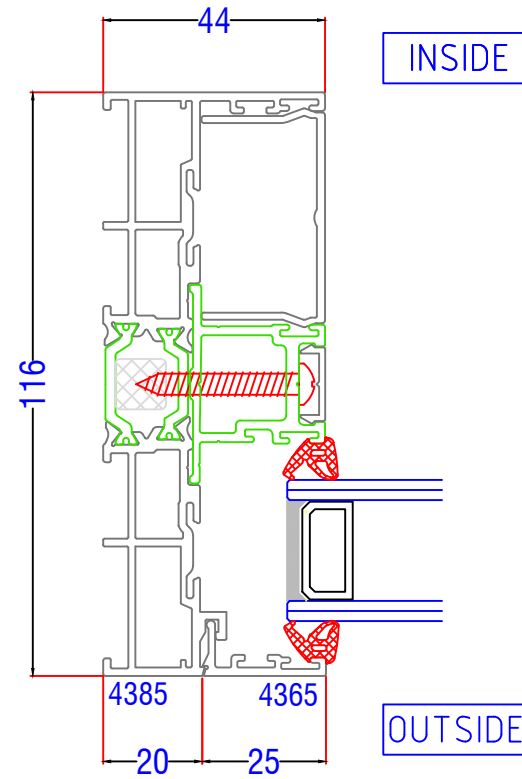
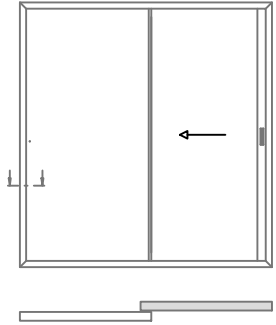

InfiniGLIDE3 - Typical Sections

Duo Frame - Sliding Panel Jamb

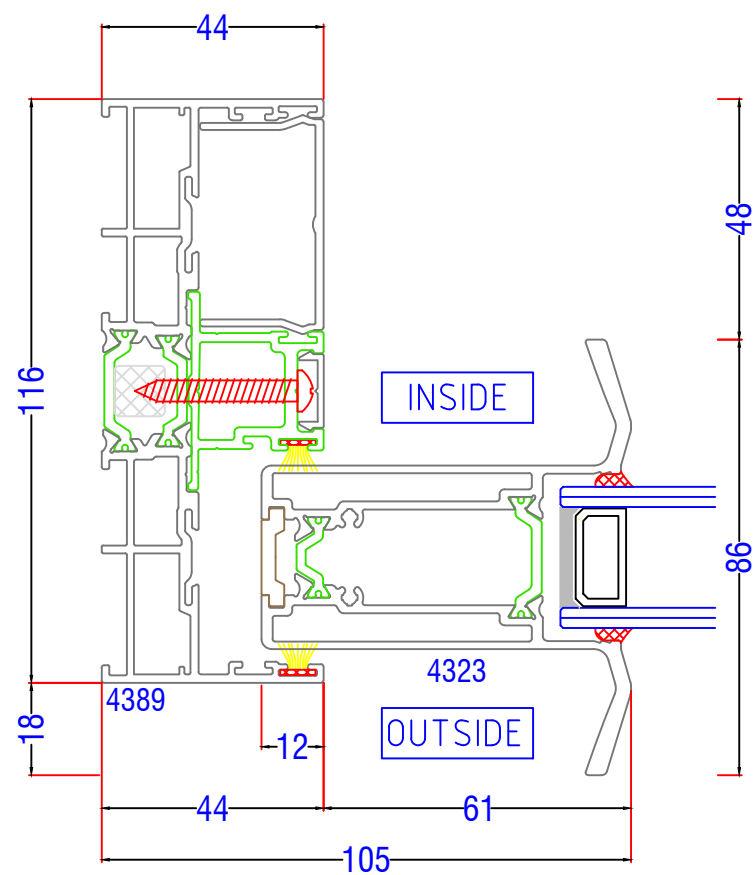
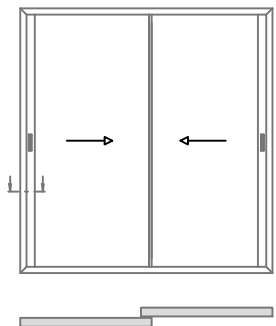

InfiniGLIDE3 - Typical Sections

Tri Frame - Fixed Panel Jamb

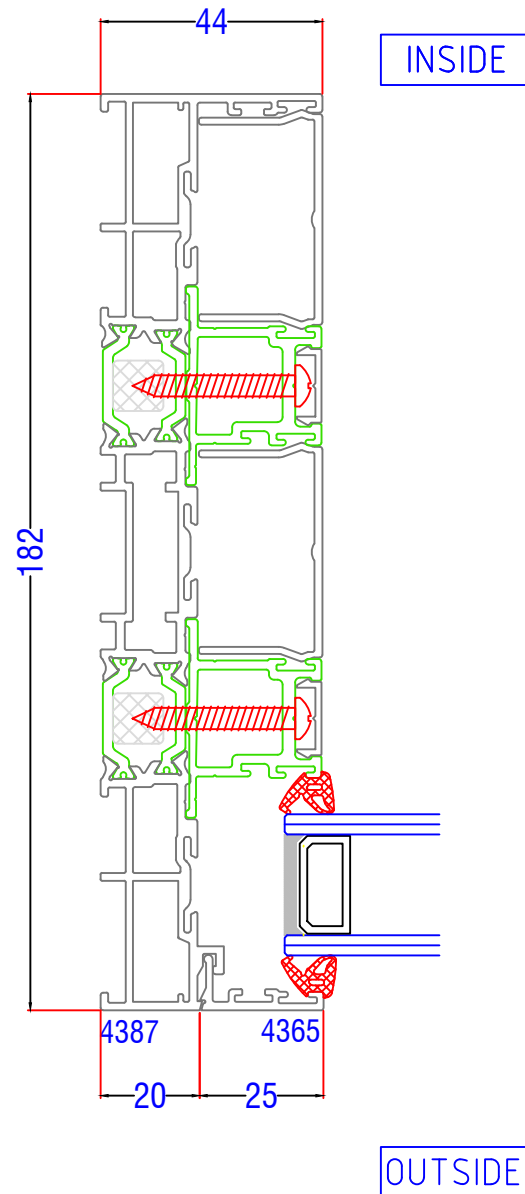
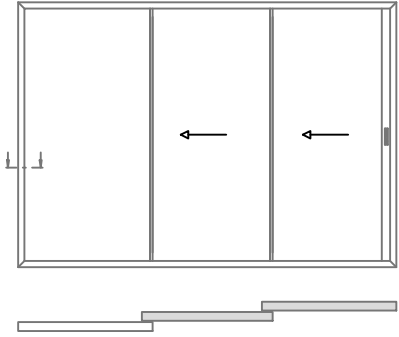

InfiniGLIDE3 - Typical Sections

Tri Frame - Sliding Panel Jamb

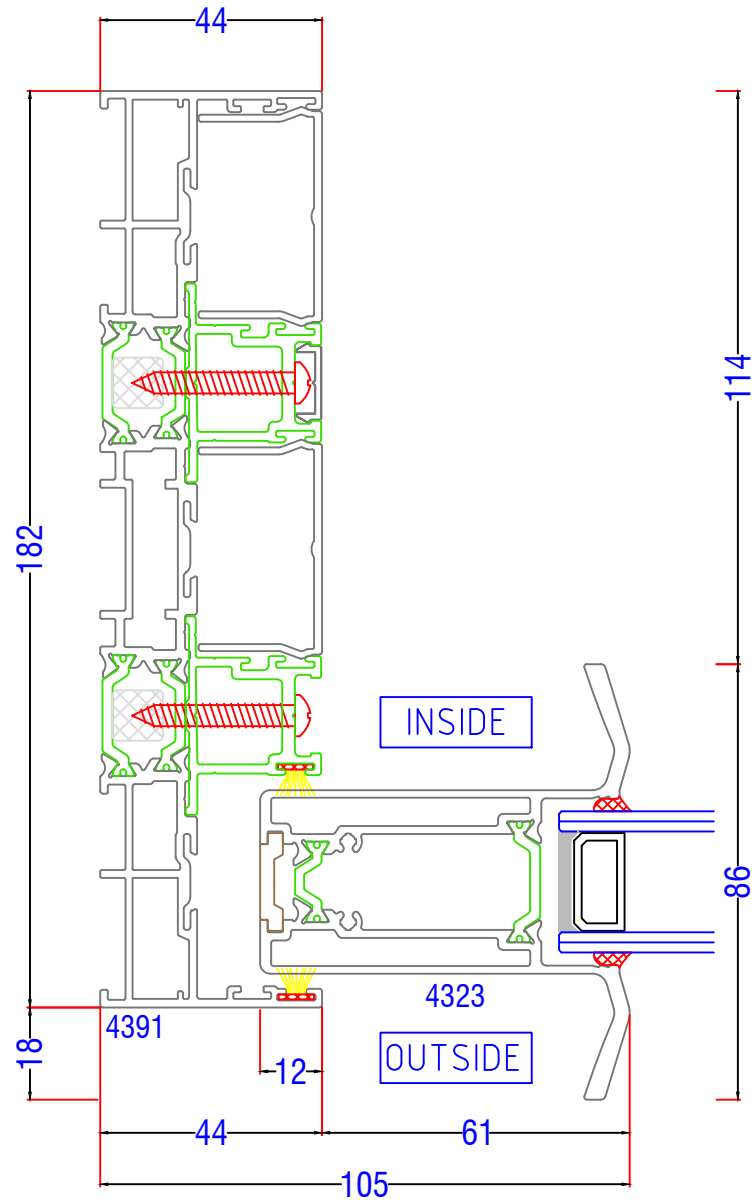
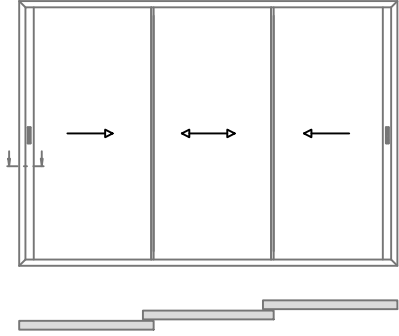

InfiniGLIDE3 - Typical Sections

Duo Frame - Fixed Panel Threshold

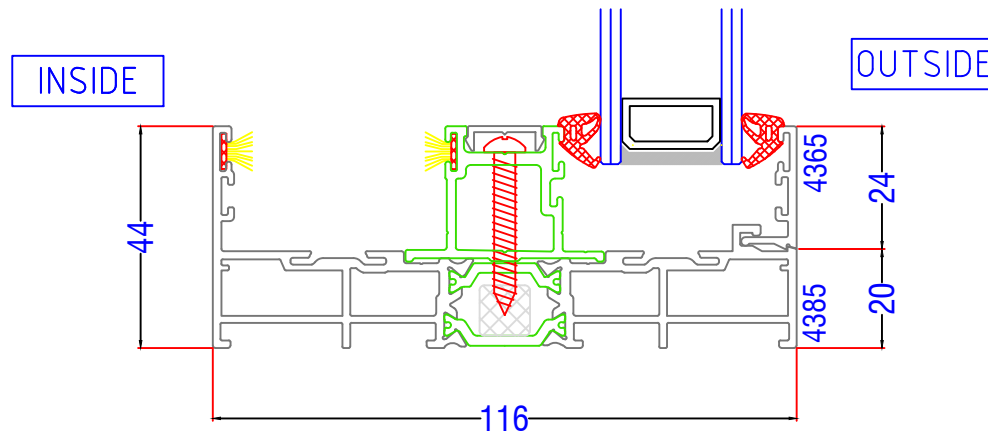
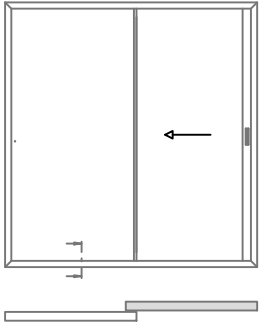

InfiniGLIDE3 - Typical Sections

Duo Frame - Sliding Panel Threshold

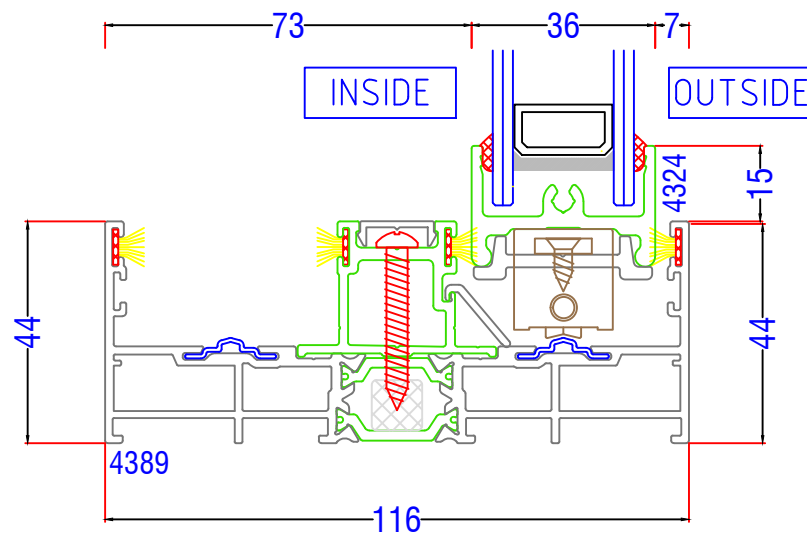
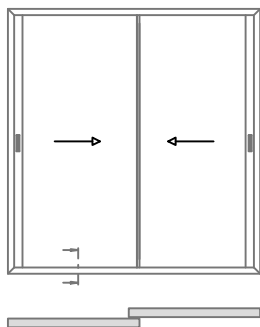

InfiniGLIDE3 - Typical Sections

Tri Frame - Fixed Panel Threshold

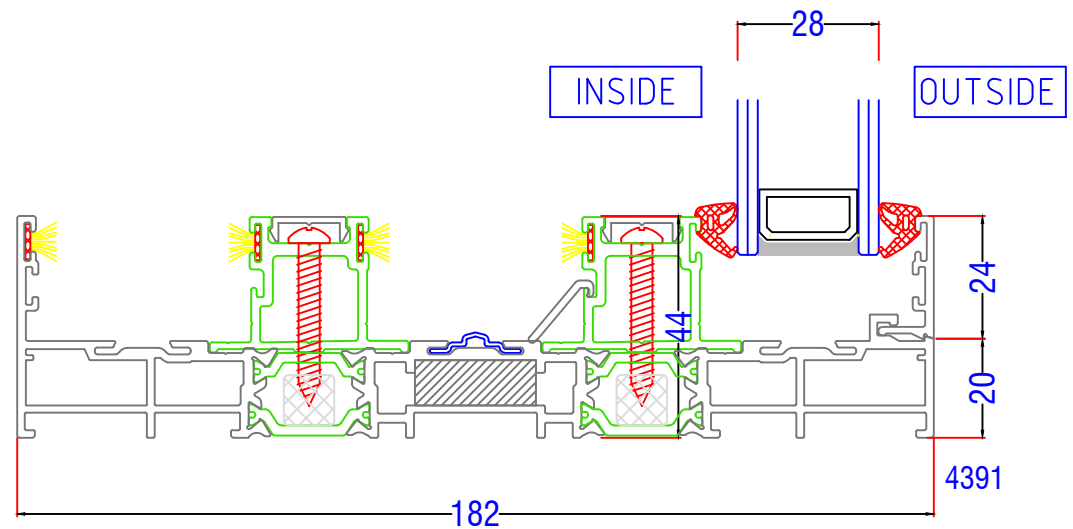
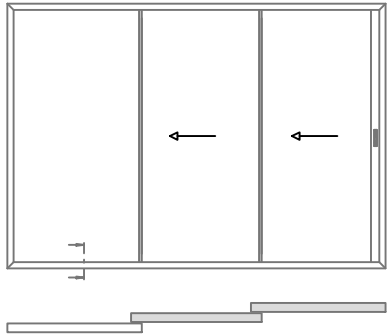

InfiniGLIDE3 - Typical Sections

Tri Frame - Sliding Panel Threshold

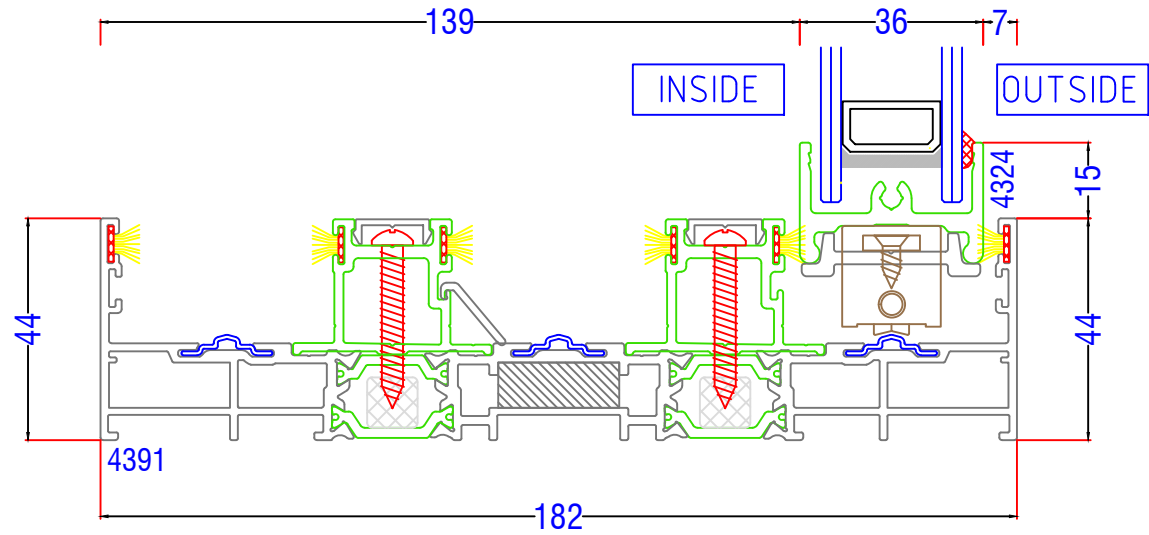
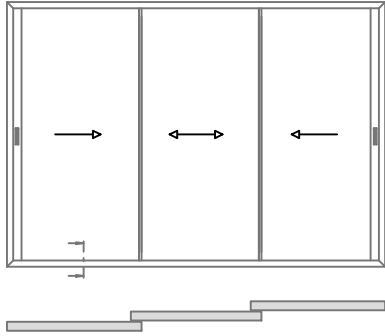

InfiniGLIDE3 - Typical Sections

Duo Frame - Fixed Panel Head

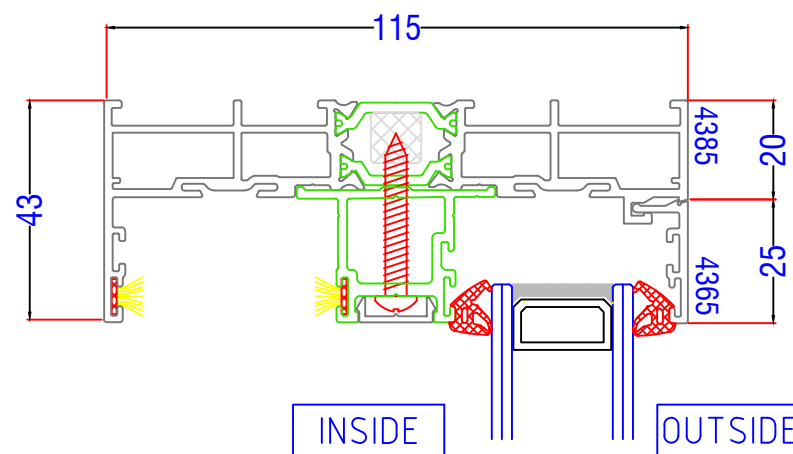
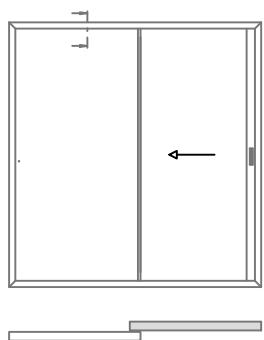

InfiniGLIDE3 - Typical Sections

Duo Frame - Sliding Panel Head

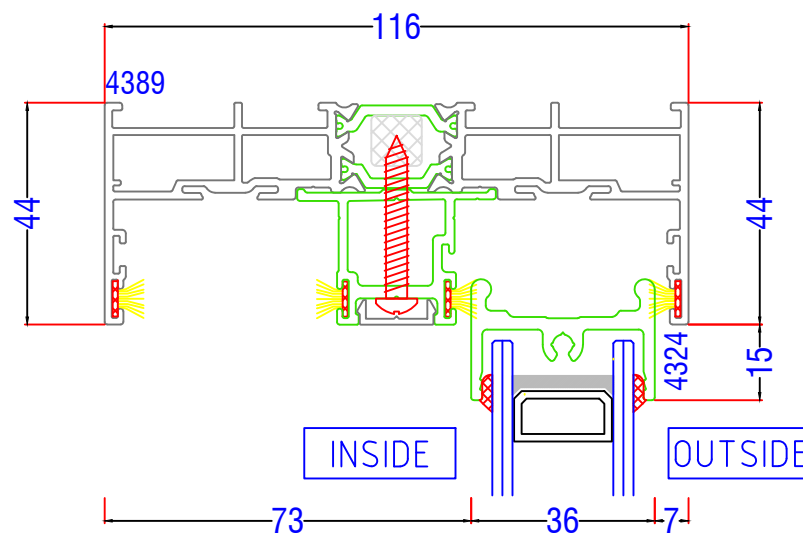
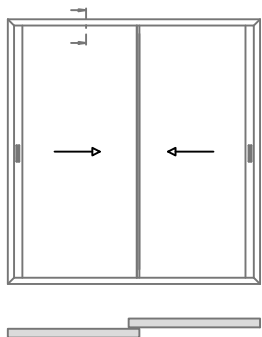

InfiniGLIDE3 - Typical Sections

Tri Frame - Fixed Panel Head

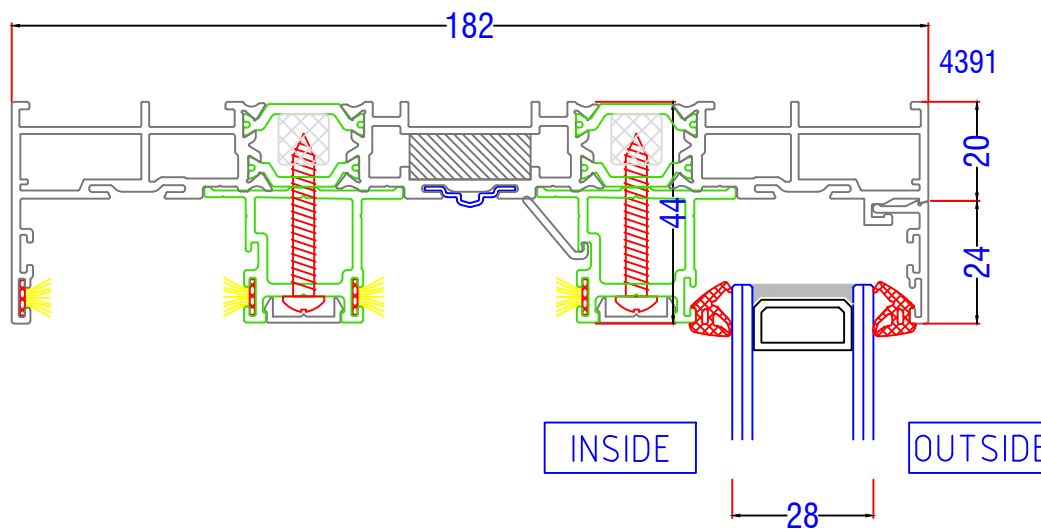
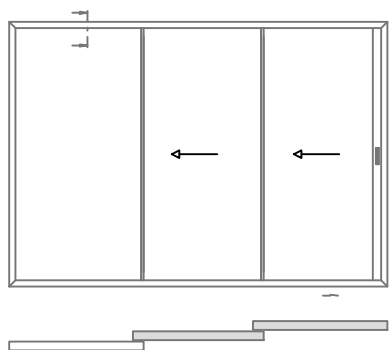

InfiniGLIDE3 - Typical Sections

Tri Frame - Sliding Panel Head

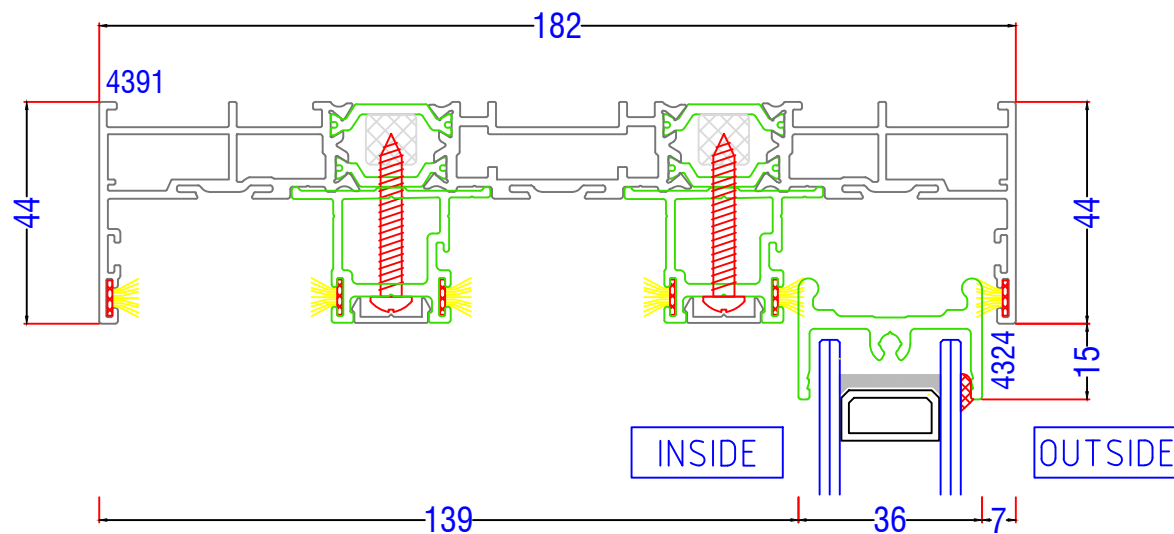
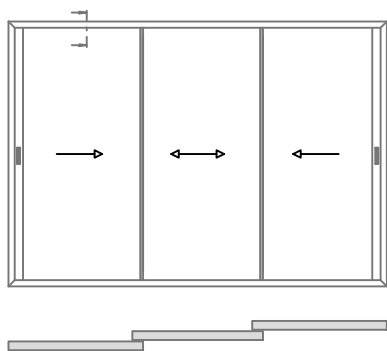

InfiniGLIDE3 - Typical Sections

Interlock Slide - Standard Profile

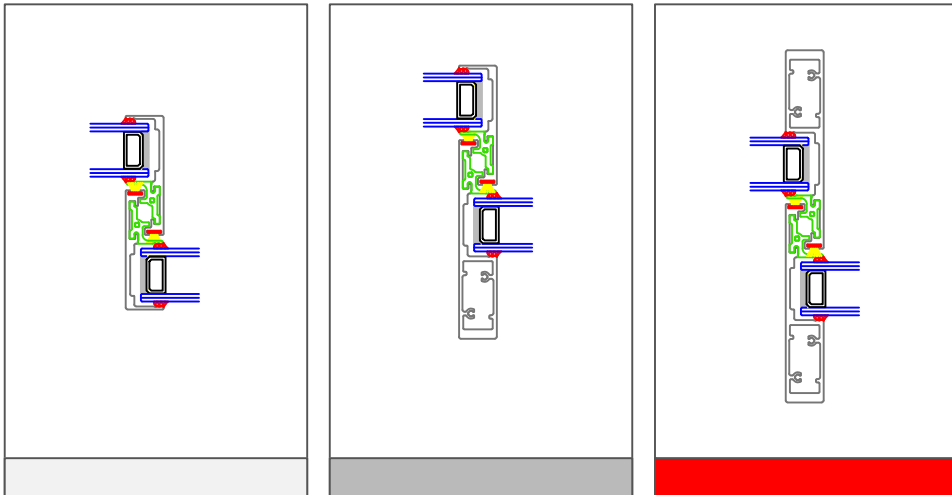
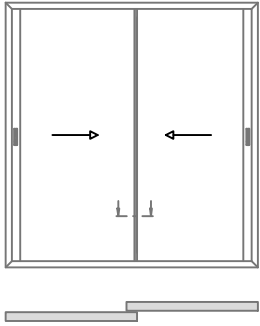

600Pa - Standard Interlock																
Door	Door Panel Width / interlock Split (mm)															
Height	500	600	700	800	900	1000	1100	1200	1300	1400	1500	1600	1700	1800	1900	2000
1800																
1900																
2000																
2100																
2200																
2300																
2400																
2500																
2600																
2700																
2800																
2900																
3000																

800Pa - Standard Interlock																
Door	Door Panel Width / interlock Split (mm)															
Height	500	600	700	800	900	1000	1100	1200	1300	1400	1500	1600	1700	1800	1900	2000
1800																
1900																
2000																
2100																
2200																
2300																
2400																
2500																
2600																
2700																
2800																
2900																
3000																

InfiniGLIDE3 - Typical Sections

Interlock Slide - Standard Profile

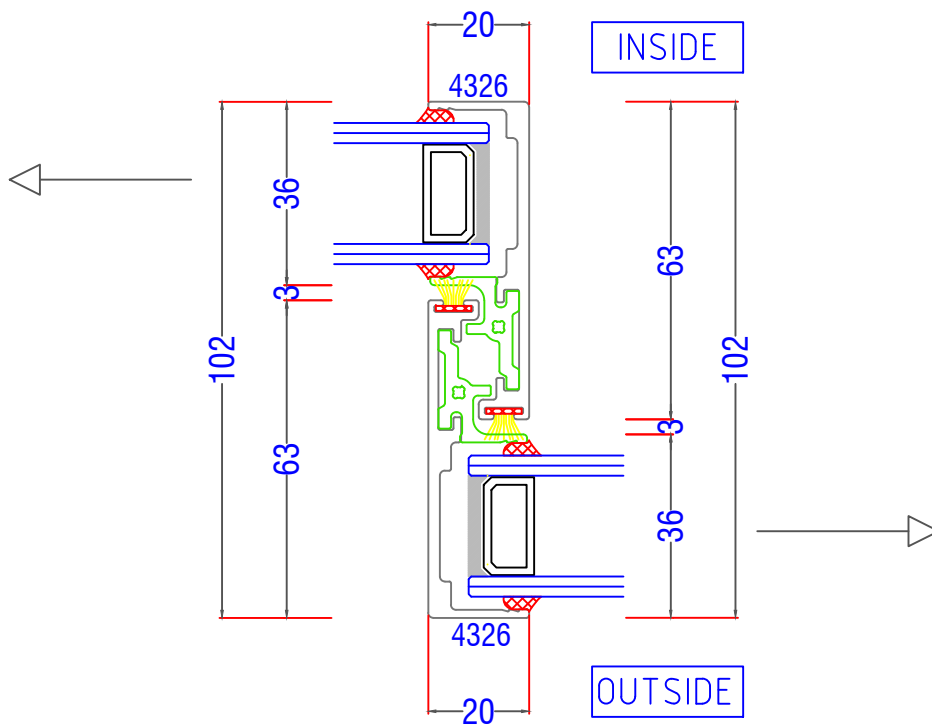
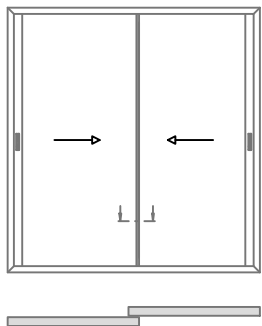

InfiniGLIDE3 - Typical Sections

Interlock Slide - Reinforced Profile Outside Only

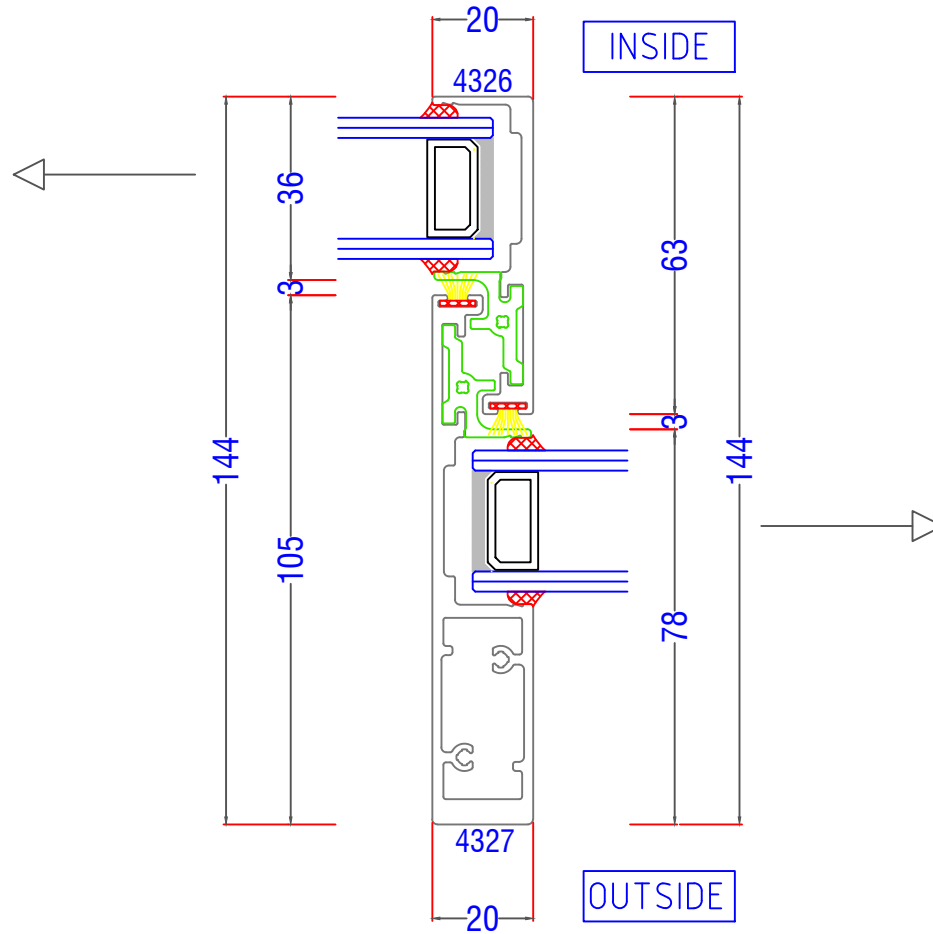
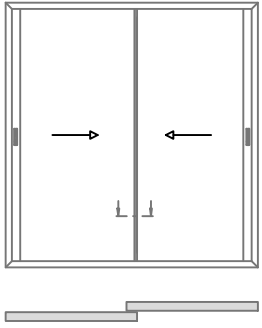

InfiniGLIDE3 - Typical Sections

Interlock Slide - Reinforced Profile Inside and Outside

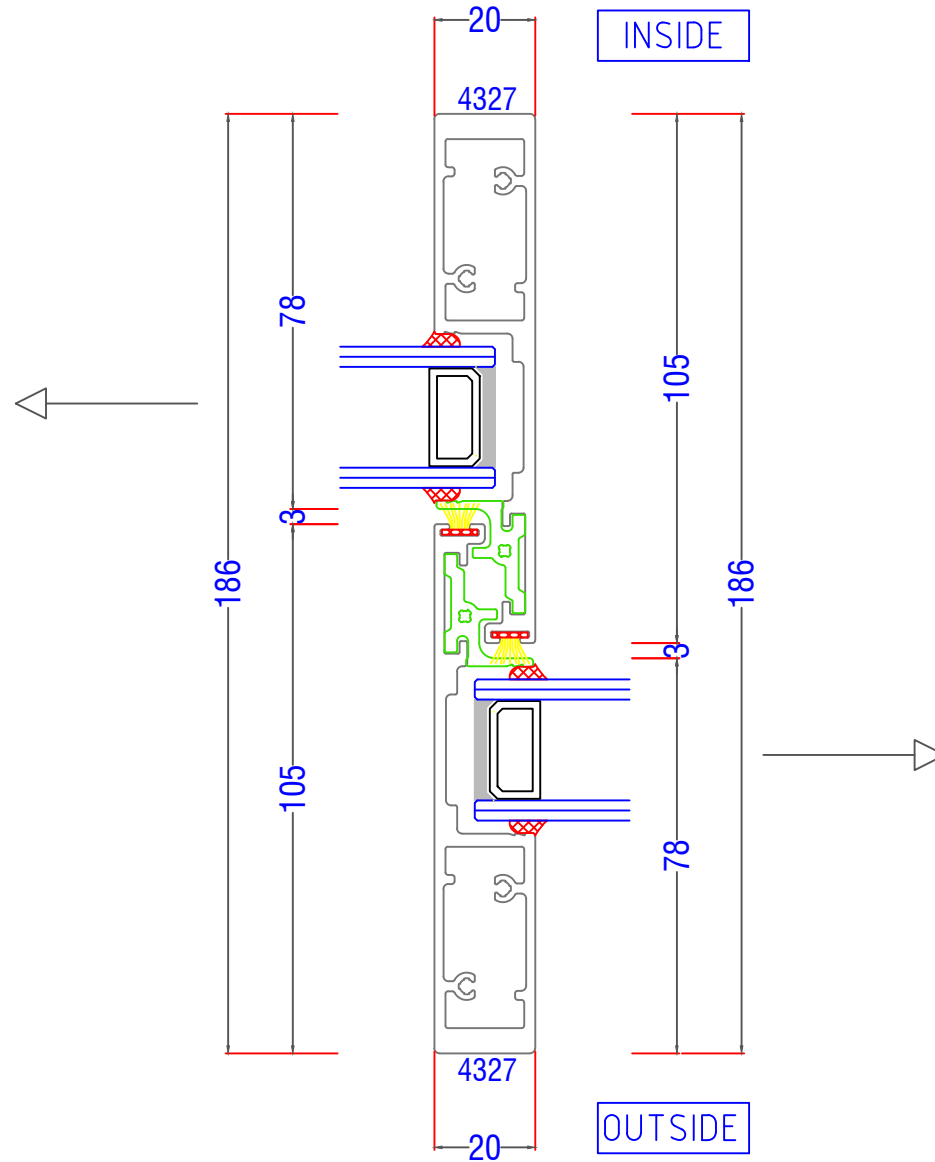
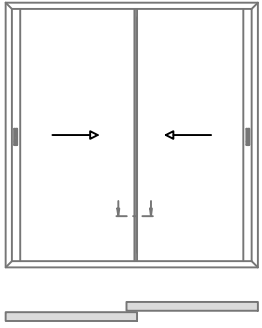

InfiniGLIDE3 - Typical Sections

Meeting Stile

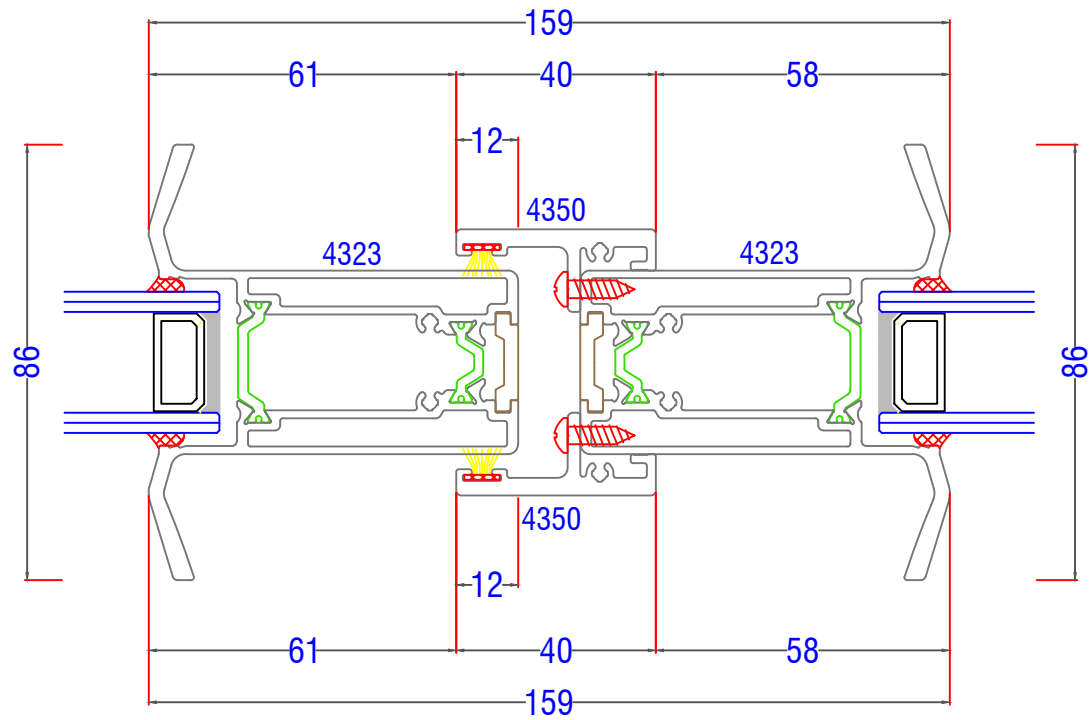
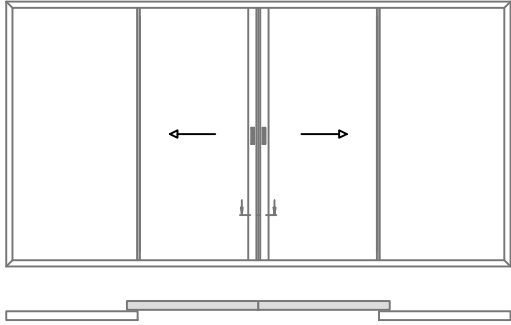

InfiniGLIDE3 - Typical Sections

Duo Frame - 177mm

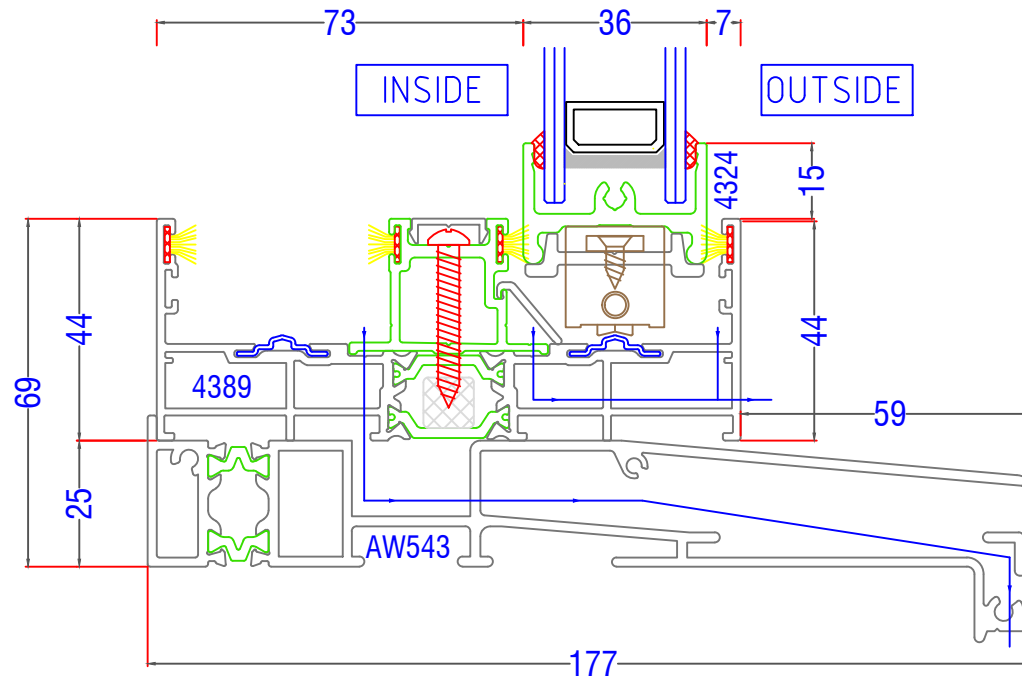
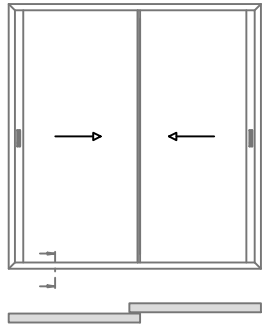

InfiniGLIDE3 - Typical Sections

Duo Frame - 60mm Cill Nose

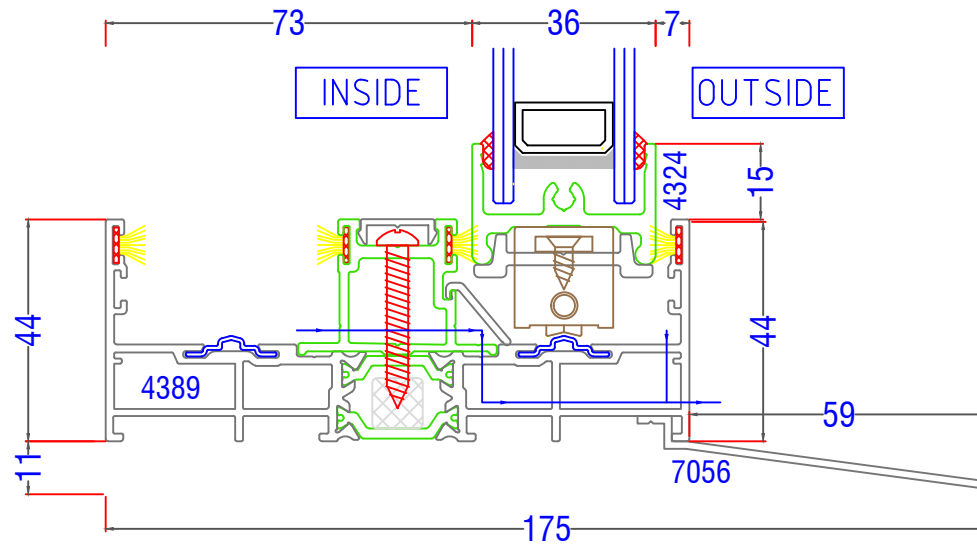
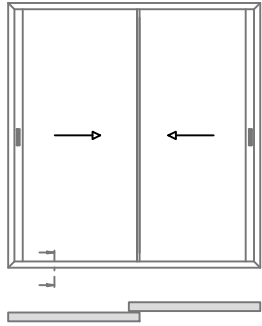

InfiniGLIDE3 - Typical Sections

Duo Frame - Drainage Base + Gutter

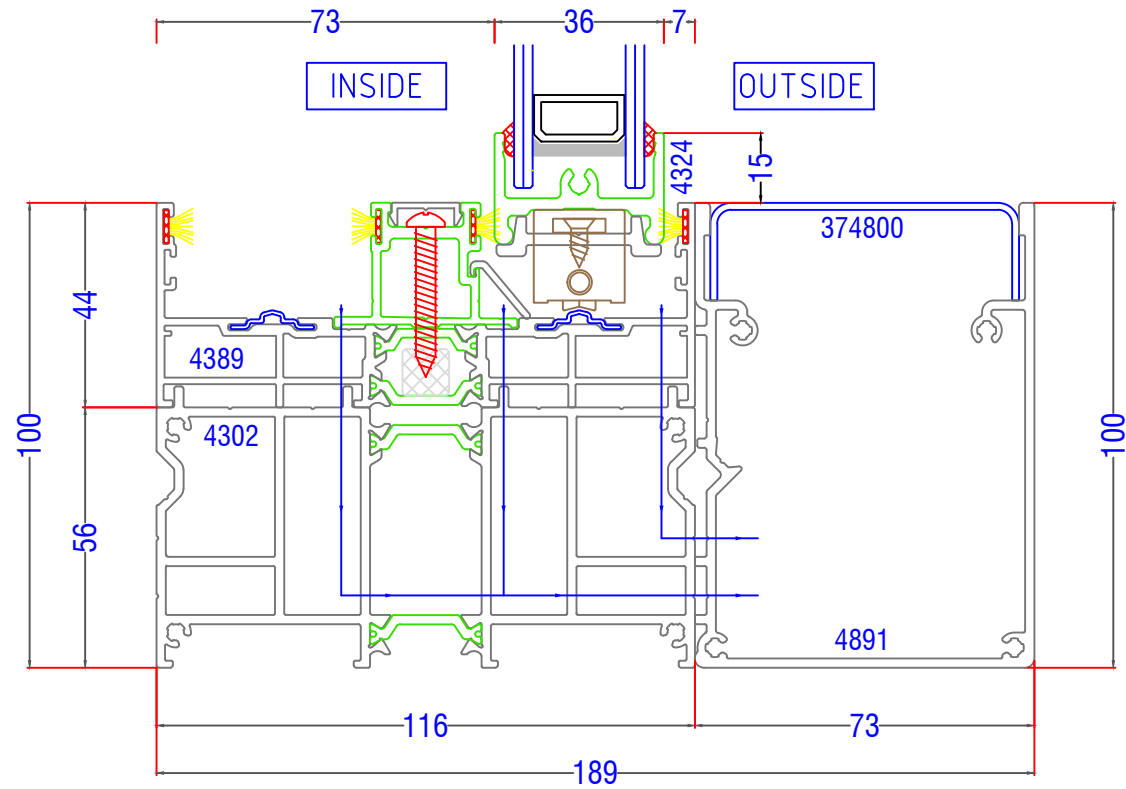
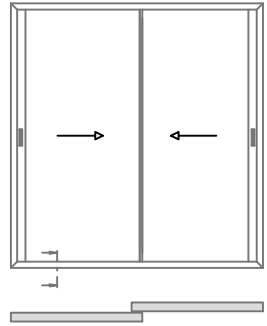

InfiniGLIDE3 - Typical Sections

Tri Frame - Drainage Base

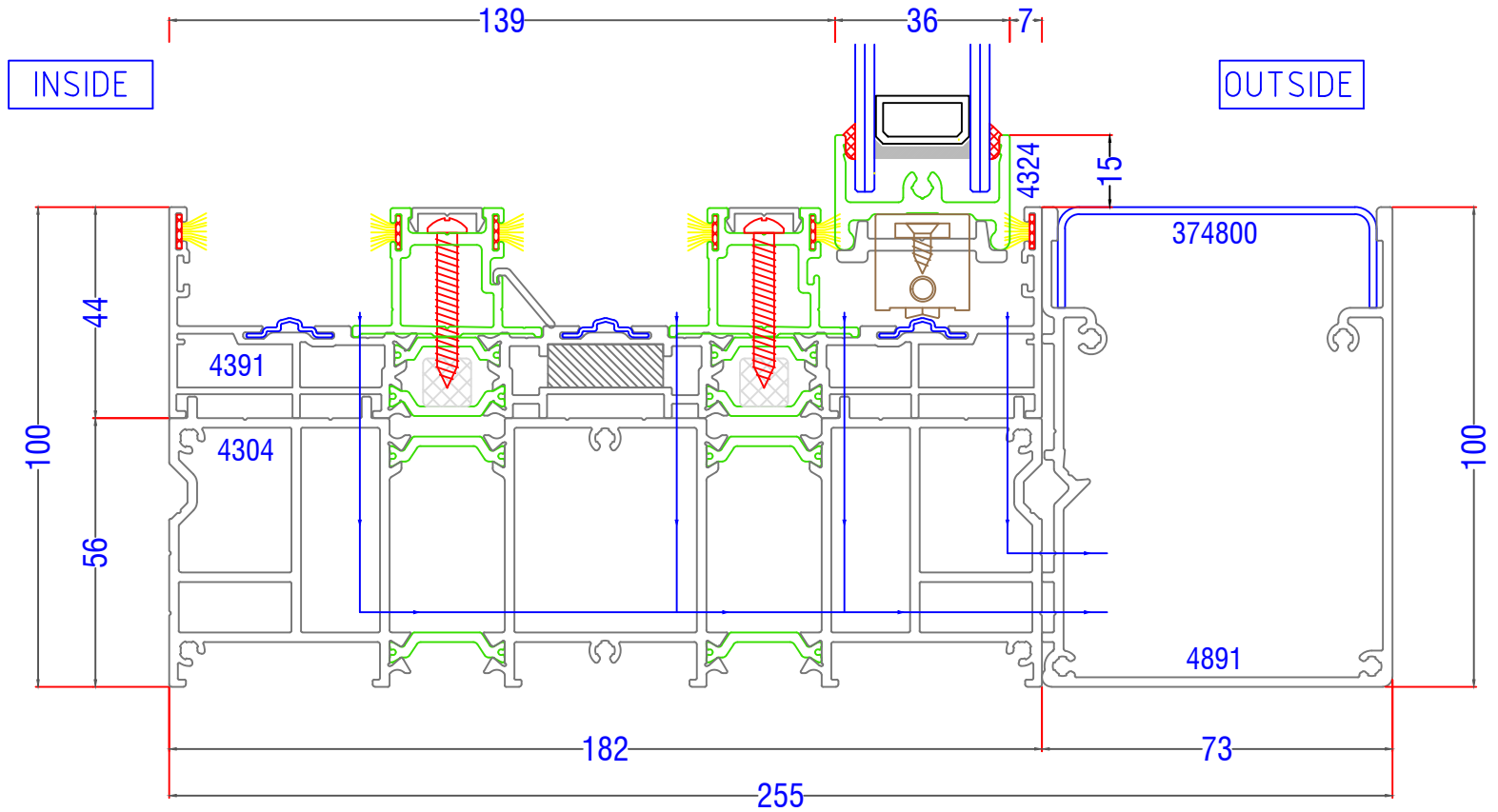
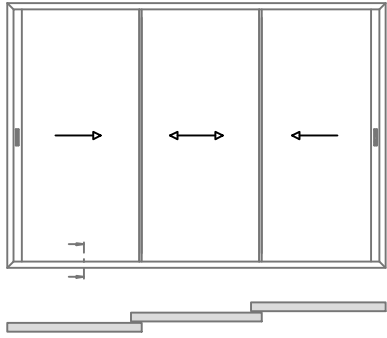

InfiniGLIDE3 - Typical Sections

Tri Frame - BLANK

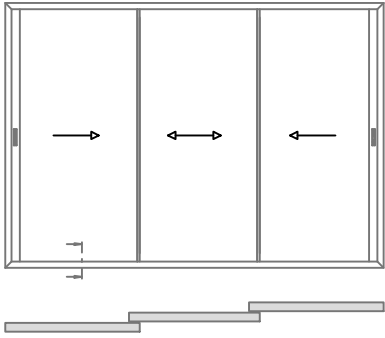

BLANK

InfiniGLIDE3 - Typical Sections

Duo Frame - Add On + Trickle Vent

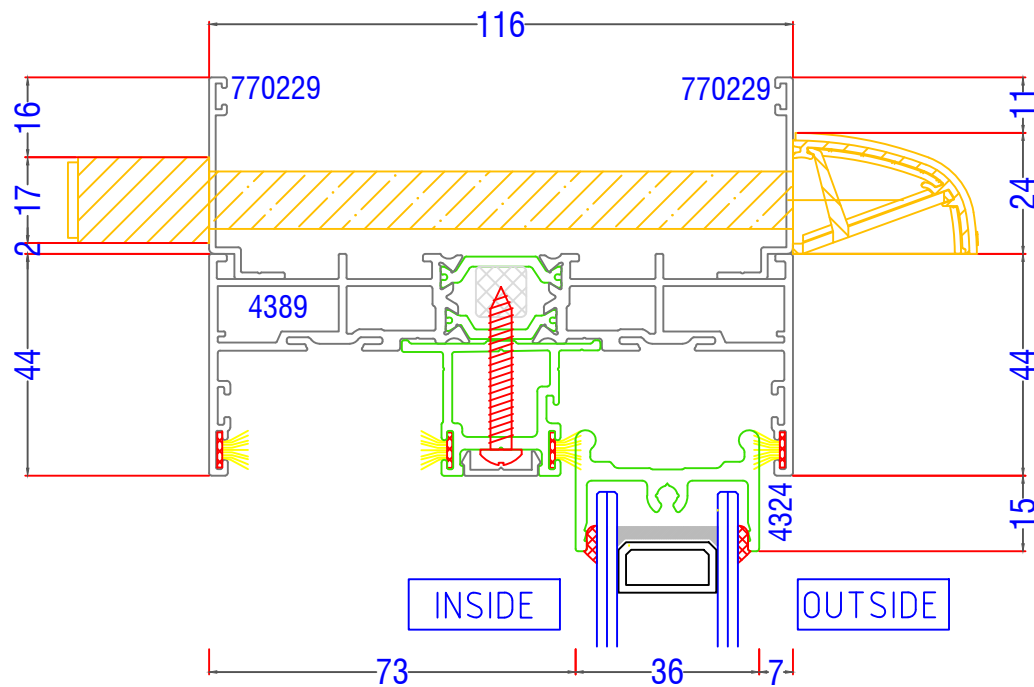
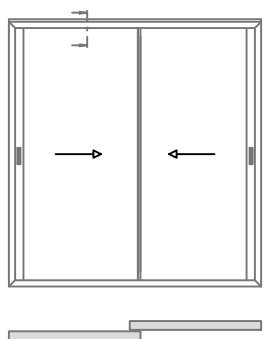

InfiniGLIDE3 - Typical Sections

Tri Frame - Add On + Trickle Vent

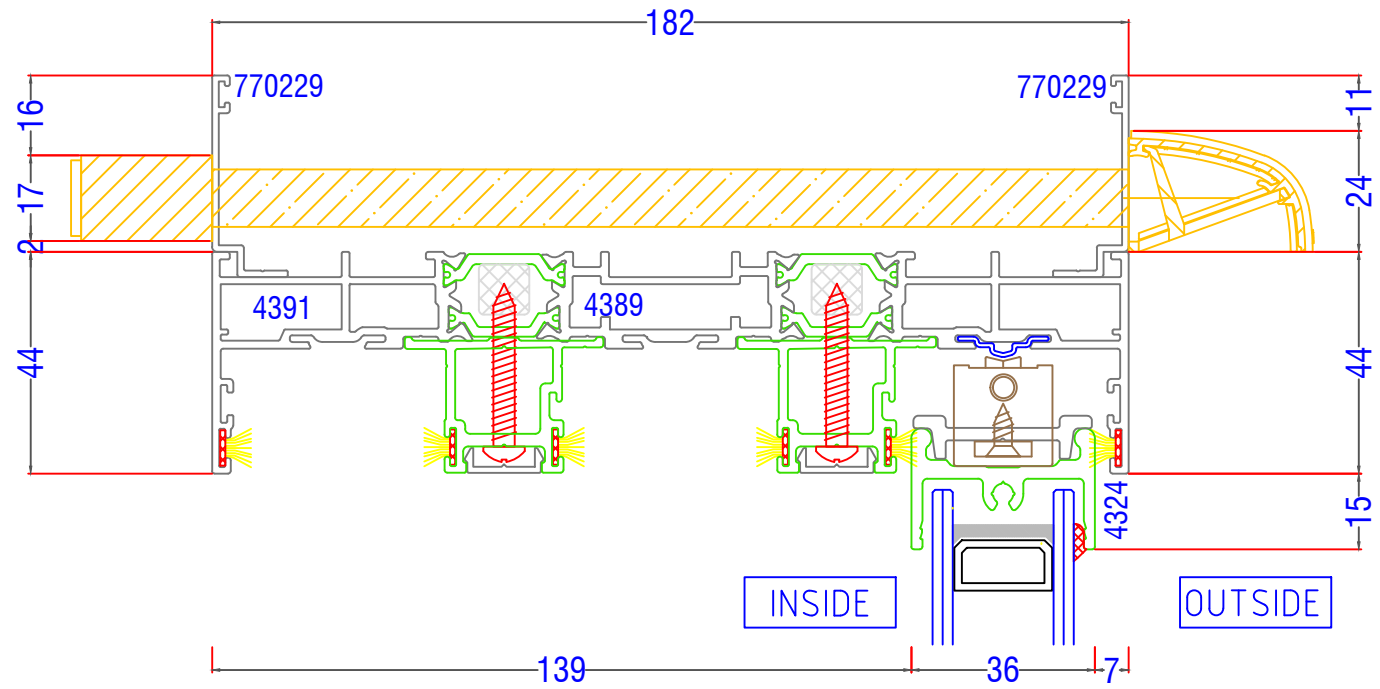
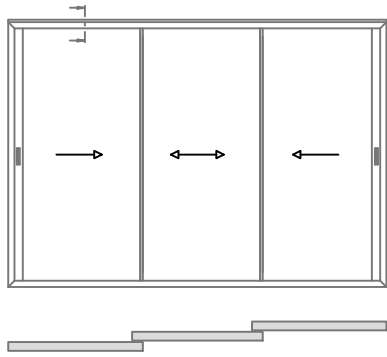

InfiniGLIDE3 - Typical Sections

Dual Frame - Floating Corner Post

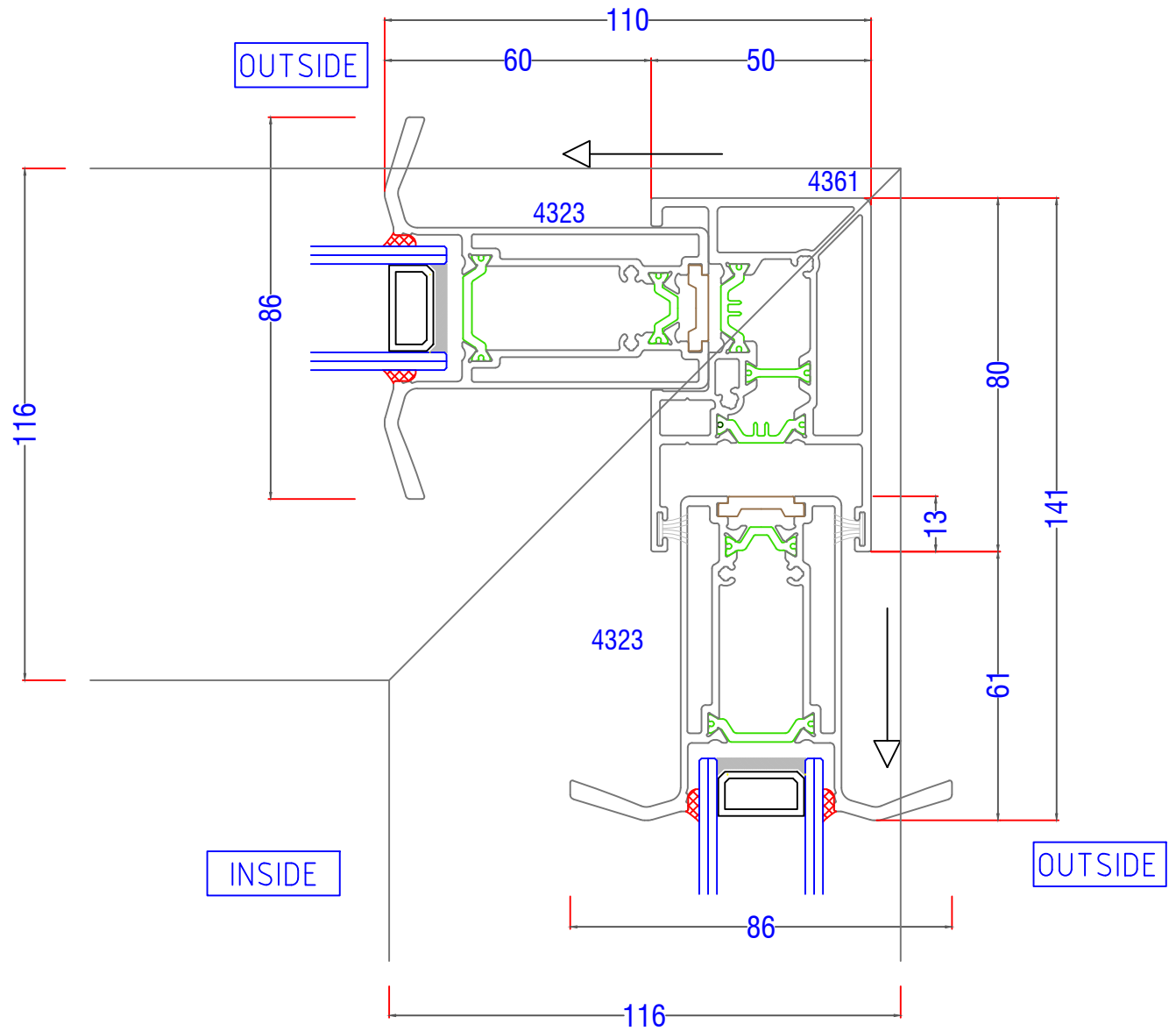
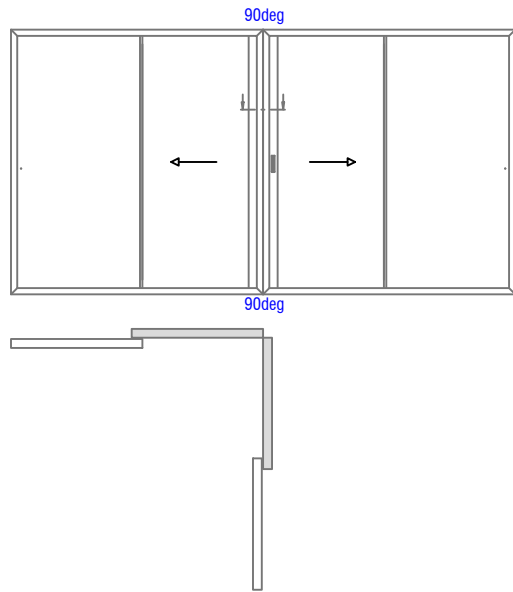

InfiniGLIDE3 - Typical Sections

Dual Frame - Glass-to-Glass Corner

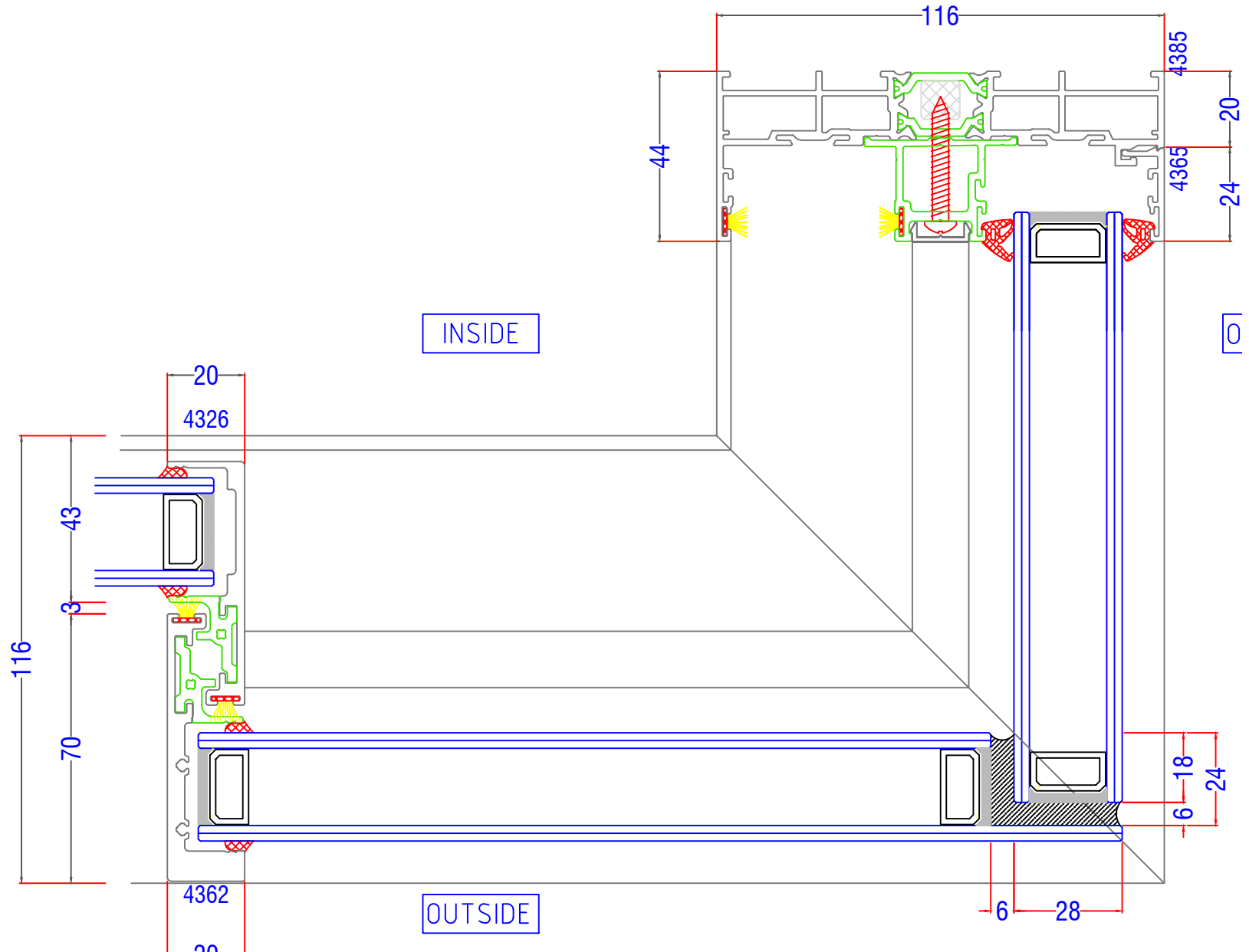
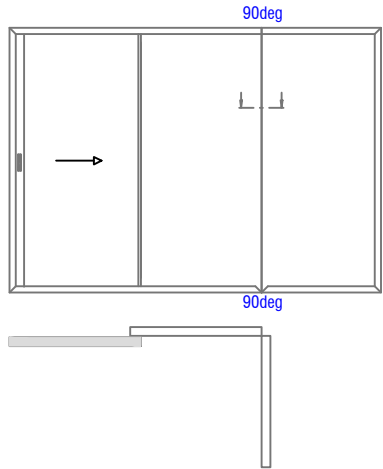



Glass & Glazing Federation Member

Official Police Security Initiative

Arkay Windows is a specialist large-scale fabricator with over 30 years experience based in Watford, North West London.

Through growth built on putting our customers first, we have risen to supply some of the country's biggest retail companies, contractors and commercial installers.



Watford: 01923 803923
London: 020 8889 6821

sales@arkaywindows.com
www.arkaywindows.com

